

Wheel End 929-966

Hubodometers	930-931
Bearings	932-933
Hubs & Drums	934-956
Assemblies	934
Drums	935-936
Hubs	937-938
Hubcaps	939-951
Seals.	952-956
Wheels	957-959
Rims	958
Spacer Bands	959
Wheel Attaching Parts	960-966



Hubodometers

Stemco

DataTrac® Pro

Part Number	RPM
STE600-5526	526
STE600-5529	529
STE600-9999	Programmable



Accessories

Programmer
STE801-6000

Electronic Mileage Counter, LCD

Mechanical

Part Number	RPM
STE650-0598	500
STE650-0601	504
STE650-0608	520
STE650-0610	522
STE650-0613	532
STE650-0626	570

Part Number	RPK
STE650-0532	300
STE650-0539	315
STE650-0545	324



RPM



RPK

Veeder-Root

Mechanical

Part Number	RPM
VEE777717-500	500
VEE777717-510	510
VEE777717-514	514
VEE777717-520	520
VEE777717-572	572

Part Number	RPK
VEE777727-310	310



STEMCO

VEE-ROOT

Hubodometers

WHL

More Information

www.MyAuroraPlus.com

Need more information on a particular trailer? Log into www.MyAuroraPlus.com for Aurora's Graphical Bill of Material (GBOM). Easily point and click through visual elements of a trailer to drill down to an individual trailer component.

Hubdometers Brackets

Bolt Circle Diameter	Stud Size	Height	
			NATW084B

Federal Mogul



Bolt Circle Diameter	Stud Size	Height	
5-1/2 in.	5/16 in.	3-1/2 in.	VEE325614-012

Veeder-Root



Part Number	Height	Stud Size	Bolt Circle Diameter
STE610-0028	4 in.	5/16 in.	5-1/2 in.
STE610-0065	3-1/2 in.	5/16 in.	5-1/2 in.
STE610-0084	5 in.	5/16 in.	6-3/4 in.



Stemco

More Information Hubdometers

A Hubdometer is fixed to an axle of your trailer or truck in order to measure how many miles your vehicle has traveled. Being able to accurately gauge your traveled distance, you can reduce the number of times you may need to stop for unexpected maintenance.

Bearings

Industry Standard Numbers

Cone	+	Cup	=	Set	Spindle	Axle
580		572		SET401	Tapered	Drive
582		572		SET402	Tapered	Drive
594A		592A		SET403	Tapered	Drive
663		653		SET405	Tapered	Drive
3782		3720		SET406	Tapered	Steer
39590		39520		SET408	Tapered	Drive
47686		47620		SET411	Tapered	Drive
HM212047		HM212011		SET412	Tapered	Steer, Trailer
HM212049		HM212011		SET413	Tapered, TN	Steer, Trailer
HM218248		HM218210		SET414	Tapered, TN	Trailer
HM518445		HM518410		SET415	Parallel	Trailer
47679		47620		SET426	Tapered	Drive



Manufacturer Specific

Manufacturer	Prefix	Cone Example	Set Example
Federal Mogul	NAT	NAT580	NATSET401
General Bearing	HYT	HYT580	HYTSET401
Pro-Par	PROBR	PROBR580	PROBRSET401
Timken	TIM	TIM580	TIMSET401
Stemco	STE	STE580	STEASET580-72

Quick Reference Popular Bearing Sets

Manufacturer	Set	Cone	Cup
Pro-Par	PROBRSET401	PROBR580	PROBR572
	PROBRSET403	PROBR594A	PROBR592A
	PROBRSET405	PROBR663	PROBR653
	PROBRSET406	PROBR3782	PROBR3720
	PROBRSET413	PROBRHM212049	PROBRHM212011
	PROBRSET414	PROBRHM218248	PROBRHM218210
	PROBRSET415	PROBRHM518445	PROBRHM518410
Timken	TIMSET401	TIM580	TIM572
	TIMSET402	TIM582	TIM572
	TIMSET403	TIM594A	TIM592A
	TIMSET405	TIM663	TIM653
	TIMSET406	TIM3782	TIM3720
	TIMSET408	TIM39590	TIM39520
	TIMSET411	TIM47686	TIM47620
	TIMSET412	TIMHM212047	TIMHM212011
	TIMSET413	TIMHM212049	TIMHM212011
	TIMSET414	TIMHM218248	TIMHM218210
	TIMSET415	TIMHM518445	TIMHM518410
	TIMSET426	TIM47679	TIM47620

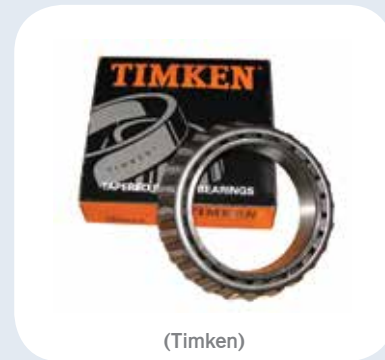

Bearings

WHL

TIMKEN

TIMKEN COMMERCIAL VEHICLE WHEEL END COMPONENTS



Timken Experience

As a company of engineers and innovators, we know the right ways to make products and the best materials to use.

Timken Tested

We have created strict testing standards drawing upon OE experience used to validate our products.

Timken Performance

Timken delivers reliable, precise products demonstrating consistent performance even outperforming the competition 2-1*.

Timken Value

Pull out a Timken product from an orange and black box with confidence, knowing it's tested, proven and will operate consistently the way it should.

2:1

Timken®
Commercial Vehicle
Wheel End Bearings

Outperform the Competition by
a 2:1 Margin.

Performance Comparison*
580/572 (Set 401)



COMMERCIAL VEHICLE WHEEL END COMPONENTS LIMITED WARRANTY

Operate with greater protection for trucks up to 5 years and 500,000 miles and trailers up to 7 years and unlimited mileage.

Scan the QR code or visit the web link for more warranty details.



www.timken.com/cvwarranty

*Information derived from Bearing Fatigue Life Test Machines. Testing methods accepted by original equipment manufacturers. Data represents the median test life.

Hub & Drum Assemblies

Part Number	Drum Type	Spoke	Diameter	Spacer	Bearing Cup Inner/ Outer	Included
KIC001-75000TH	52230-10	5	20 in.	4.00 in.	HM218210 HM212011	cups, clamps, tone rings & spacer
	Drum Type	Spoke	Diameter	Spacer	Bearing Cup Inner/ Outer	Included
KICHUB-75000TH	None	5	20 in.			clamps, tone ring & spacer
WEB75209--A	Spoke	5	20 in.	4.00 in.	HM218210 HM212011	cups, clamps, studs & nuts
WEB85203--A	Spoke	5	20 in.	4.00 in.	653 HM212011	cups, clamps, studs & nuts



(KIC001-75000TH)



(KICHUB-75000TH)



(WEB75209--A/
WEB85203--A)

Cross Reference

Brake Drums

Pro-Par	Webb	Gunite	Meritor	KIC
PROBD16.5X7BMI	WEB66864B	3600AX	DAY85-123207-002	KIC60001-018
PROBD16.5X7BM				KIC60001-018 USA

KIC	Webb	Gunite	Meritor
KIC51952-11	WEB68897F	8656	DAY03-120743-002
KIC52020-01	WEB62200F	2705	DAY03-012582-002
KIC52120-12	WEB68981F	3295A	DAY03-122683-002
KIC52230-10	WEB67518F	2983C	DAY03-122222-002
KIC52327-10	WEB68730F	3018A	DAY03-122126-002
KIC52705-30	WEB66895F	3141	DAY03-122550-002
KIC52705-308	WEB66895B	3141X	DAY85-122550-002
KIC52877-11	WEB60876F	3120	DAY03-120877-002
KIC52890-13	WEB62997F	2997D	DAY03-123430-002
KIC53026-01	WEB66893F	3166	DAY03-122607-002
KIC53033-30	WEB66875F	3141B	DAY03-123409-002
KIC53075-018	WEB61527B	3721X	DAY85-123366-002

KIC	Webb	Gunite	Meritor
KIC54201-108	WEB61528B	3721AX	DAY85-123254-002
KIC54202-01	WEB66873F	3402	DAY03-123397-002
KIC54203-01	WEB61788F	3197	DAY03-120936-002
KIC54213-018	WEB66353B	3757X	
KIC54229-018	WEB66854B	3807X	
KIC54238-018	WEB65654B	3710X	DAY85-123383-002
KIC54248-018	WEB65152B	3687X	DAY85-123399-002
KIC54261-018	WEB66884B	3576X	DAY85-123365-002
KIC54269-018	WEB66800B	3782X	DAY85-123520-002
KIC54293-018	WEB65548B	3800X	DAY03-123448-002
KIC60001-01	WEB66864F	3600A	DAY03-123207-002
KIC60000-018	WEB56864B	3922X	

KIC

WEBB

Hubs & Drums

WHL

Disc Wheel Brake Drums

12.25 Brake Size

Part Number	Brake Size	Bolt Number	Bolt Circle Diameter	Pilot Diameter	Surface Flat	Weight	Type
WEB63631	12-1/4 x 7-1/2	10	8-3/4 in.	7-1/8 in.	8-1/8 in.	80.90 lbs	OEM
WEB63637	12-1/4 x 7-1/2	6	8-1/4 in.	7 in.	7-13/16 in.	80.25 lbs	OEM
WEN03-00050	12-1/4 x 7-1/2	8	10-53/64 in.	9 in.	9-27/32 in.	93.00 lbs	Low-Boy, Cast
WEB63680F	12-1/4 x 8.00	8	10-53/64 in.		9-61/64 in.	89.80 lbs	OEM

15.00 Brake Size

Part Number	Brake Size	Bolt Number	Bolt Circle Diameter	Pilot Diameter	Surface Flat	Weight	Type
GUN3800X	15.00 x 4.00	10	11-1/4 in.	8-25/32 in.	4-1/2 in.	79.00 lbs	Tru-Pilot
CMT10009920	15.00 x 4.00	10	11-1/4 in.		4-39/64 in.	80.00 lbs	Steer, TruTurn®
CMT10081828	15.00 x 4.00	10	11-1/4 in.		4-21/32 in.	75.00 lbs	TruTurn®
DAY85-123382-002	15.00 x 4.00	10	11-1/4 in.		4-25/32 in.	67.00 lbs	Balanced
MOT90089BK	15.00 x 4.00	10	285-3/4 in.		4-33/64 in.	66.00 lbs	OEM

16.50 Brake Size

Part Number	Brake Size	Bolt Number	Bolt Circle Diameter	Pilot Diameter	Surface Flat	Weight	Type
WEB66875	16-1/2 x 7.00	8	10-53/64 in.	9 in.	7-13/16 in.	114.25 lbs	OEM
MOT88797B	16-1/2 x 7.00	8	10-53/64 in.		7-41/64 in.	92.00 lbs	OEM, Balanced
KIC53033-30	16-1/2 x 7.00	8	10-53/64 in.		7-5/8 in.	114.00 lbs	OEM
CMT10014756	16-1/2 x 5.00	10	11-1/4 in.	8-25/32 in.	5-1/2 in.	85.00	CastLite
CMT10020147	16-1/2 x 5.00	10	11-1/4 in.		5-1/4 in.	92.00 lbs	TruTurn®
CMT10041543	16-1/2 x 5.00	10	11-1/4 in.		5-41/64 in.	86.00 lbs	TruTurn®
CMT10033071	16-1/2 x 6.00	10	11-1/4		6-13/32 in.	109.00 lbs	TruTurn®
DAY53-123564-002	16-1/2 x 7.00	10	11-1/4 in.	8-17/32 in.	7-5/8 in.	112.00 lbs	
WEB66893F	16-1/2 x 7.00	10	11-1/4 in.		7-5/8 in.	115.75 lbs	OEM
DAY03-122607-002	16-1/2 x 7.00	10	11-1/4 in.		7-5/8 in.	114.00 lbs	OEM
GUN3922X	16-1/2 x 7.00	10	11-1/4 in.	8-25/32 in.	7 in.	103.00 lbs	Value, Balanced
WEB66826B	16-1/2 x 7.00	10	11-1/4 in.		7-3/8 in.	116.00 lbs	
WEB56864B	16-1/2 x 7.00	10	11-1/4 in.		7-9/16 in.	105.00 lbs	OEM, Balanced
GUN3600AX	16-1/2 x 7.00	10	11-1/4 in.		7-9/16 in.	108.00 lbs	Balanced
CMT10009830	16-1/2 x 7.00	10	11-1/4 in.		7-9/16 in.	112.00 lbs	Balanced, TruTurn®
WEB66884B	16-1/2 x 7.00	10	11-1/4 in.		7-5/8 in.	116.00 lbs	Balanced
DAY03-123207-002	16-1/2 x 7.00	10	11-1/4 in.		7-5/8 in.	120.00 lbs	OEM
DAY53-123537-002	16-1/2 x 7.00	10	11-1/4 in.		7-5/8 in.	92.00 lbs	OEM, Balanced
DAY85-123788-002	16-1/2 x 7.00	10	11-1/4 in.		7-35/64 in.	103.50 lbs	Balanced
PROBD16.5X7BML	16-1/2 x 7.00	10	11-1/4 in.		7-35/64 in.	102.00 lbs	Balanced
PROBD16.5X7BMLI	16-1/2 x 7.00	10	11-1/4 in.		7-35/64 in.	102.00 lbs	Balanced
PROBD16.5X7BM	16-1/2 x 7.00	10	11-1/4 in.		7-35/64 in.	108.00 lbs	Balanced
PROBD16.5X7BMI	16-1/2 x 7.00	10	11-1/4 in.		7-35/64 in.	108.00 lbs	Balanced
WEB66864	16-1/2 x 7.00	10	11-1/4 in.		7-35/64 in.	108.00 lbs	Unbalanced
WEB77864BW	16-1/2 x 7.00	10	11-1/4 in.	7-35/64 in.	111.00 lbs	Vortex	
MOT89996B	16-1/2 x 7.00	10	11-1/4 in.	7-39/64 in.	89.00 lbs	Balanced	
WEB66864B	16-1/2 x 7.00	10	11-1/4 in.	8-7/8 in.	7-35/64 in.	108.00 lbs	Balanced



Hubs & Drums



Disc Wheel Brake Drums

16.50 Brake Size

Part Number	Brake Size	Bolt Number	Bolt Circle Diameter	Pilot Diameter	Surface Flat	Weight	Type
KIC52705-308	16-1/2 x 7	10	11-1/4 in.	9 in.	7-53/64 in.	114.00 lbs	OEM, Balanced
WEB62200	16-1/2 x 7	10	11-1/4 in.		7-3/8 in.	109.00 lbs	
WEB60876	16-1/2 x 7	10	11-1/4 in.		7-1/2 in.	109.00 lbs	
DAY03-120877-002	16-1/2 x 7	10	11-1/4 in.	9-7/16 in.	7-1/2 in.	116.00 lbs	OEM
KIC52877-11	16-1/2 x 7	10	11-1/4 in.		7-1/2 in.	121.00 lbs	OEM
KIC52020-01	16-1/2 x 7	10	11-1/4 in.		7-5/8 in.	99.00 lbs	OEM
KIC53026-01	16-1/2 x 7-13/16	10	11-1/4 in.	8-17/32 in.	7-13/16 in.	114.00 lbs	OEM
DAY53-123535-002	16-1/2 x 8	10	11-1/4 in.		8-39/64 in.	103.80 lbs	
CMT10080760	16-1/2 x 8	10	11-1/4 in.		8-25/32 in.	120.00 lbs	TruTurn®
WEB66854B	16-1/2 x 8-5/8	10	11-1/4 in.		8-31/32 in.	120.00 lbs	OEM
DAY53-123544-002	16-1/2 x 8-5/8	10	11-1/4 in.	8-25/32 in.	9-5/64 in.	104.00 lbs	
CMT10012097	16-1/2 x 8-5/8	10	11-1/4 in.		9-1/8 in.	122.00 lbs	Balanced, TruTurn®
DAY03-123406-002	16-1/2 x 8-5/8	10	11-1/4 in.		9-15/64 in.	142.00 lbs	
CMT10025912	16-1/2 x 8-5/8	10	11-1/4 in.		9-9/16 in.	137.00 lbs	TruTurn®
WEB66814	16-1/2 x 8-5/8	10	11-1/4 in.		9-5/8 in.	131.58 lbs	OEM

Spoke Wheel Brake Drums

12.25 Brake Size

Part Number	Brake Size	Bolt Number	Bolt Circle Diameter	Pilot Diameter	Surface Flat	Weight	Type
WEB63637	12-1/4 x 7-1/2	6	8-1/4 in.	7 in.	7-25/32 in.	80.00 lbs	Unbalanced
WEB63617	12-1/4 x 7-1/2	6	10 in.	8-1/2 in.	8 in.	69.70 lbs	OEM

16.50 Brake Size

Part Number	Brake Size	Bolt Number	Bolt Circle Diameter	Pilot Diameter	Surface Flat	Weight	Type
DAY03-122222-002	16-1/2 x 7.00	5, 6	11 in.		7-3/8 in.	107.00 lbs	OEM
WEB67518	16-1/2 x 7.00	5, 6	11 in.	9-7/16 in.	7-3/8 in.	105.38 lbs	OEM
KIC52230-10	16-1/2 x 7.00	5, 6	11 in.		7-1/2 in.	99.00 lbs	OEM
WEB68765	16-1/2 x 7.00	5, 6	11-1/4 in.	9-1/2 in.	7-7/16 in.	108.00 lbs	OEM
DAY03-122126-002	16-1/2 x 7.00	10	11-1/4 in.		7-7/16 in.	115.00 lbs	OEM
WEB68730	16-1/2 x 7.00	10	11-1/4 in.	9-1/2 in.	7-7/16 in.	106.85 lbs	OEM
KIC52327-10	16-1/2 x 7.00	10	11-1/4 in.		7-1/2 in.	108.00 lbs	Fruehauf

KIC

WEBB

MERTOR

CONMET

Hubs & Drums

WHL

Hubs

Hub Piloted

Part Number	Stud Number	Hubcap Type	Stud Length	Wheel	Inner Bearing Cup	Outer Bearing Cup	Tone Ring	Mount
CMT10082225	10	Bolt On	Long	Aluminum	TN PreSet	TN PreSet	Yes	Outboard
CMT10082229	10			Aluminum	HM518410			
CMT10082250	10			Aluminum	HM218210	HM212011	Yes	
CMT10082252	10	Bolt On	Long	Iron	HM218210	HM212011	Yes	Outboard
CMT10082254	10	Bolt On	Long	Aluminum	HM518410	HM518410	Yes	Outboard
CMT10082256B	10		Long	Iron	HM518410	HM518410	Yes	Unimount
DAY04-15981-016	10		Short		BTH-0037	BTH-0037		Unitized
DAY04-15981-017	10		Long		BTH-0037	BTH-0037	Yes	Unitized
GUNHT818RD	10				653	HM212011		Outboard
PROHUB-00133T	8	Bolt On	Short	Steel	HM218210	HM212011	Yes	Outboard
PROHUB-01025LT	10	Bolt On	Long	Aluminum	HM212010	HM218211	Yes	Outboard
PROHUB-01025T	10	Bolt On	Short	Steel	HM212010	HM218211	Yes	Outboard
PROHUB-00130LT	10	Screw On	Long	Aluminum	HM518410	HM518410	Yes	Outboard
PROHUB-00130T	10	Screw On	Short	Steel	HM518410	HM518410	Yes	Outboard
PROHUB-00133LT	8		Long		TN		Yes	Unimount
PROHUB-01043LT	10	Bolt On	Long	Aluminum	HM518410	HM518410	Yes	Outboard
PROHUB-01043T	10	Bolt On	Short	Steel	HM518410	HM518410	Yes	Outboard
MOT20161W-102	10	Bolt On	Short	Steel	HM518410	HM518410	Yes	Outboard
MTRA2-333A4733	10							Unimount
MTRA6-333A4733	10							Unimount
WEB1020P	10	No Studs						Outboard
WEB2023PT	10	Bolt On	None	None	HM218210	HM212011	Yes	Outboard
WEB20231--3T	10	Bolt On	Short	Steel	HM218210	HM212011	Yes	Outboard
WEB20231--5T	10	Bolt On	Long	Aluminum	HM218210	HM212011	Yes	Outboard
WEB23431--3T	10		Short	Steel	HM518410	HM518410		
WEB23431--5T	10	Screw On	Long	Aluminum	HM518410	HM518410	Yes	Outboard
WEN10-00106-101	10	Bolt On	Long	Aluminum	HM218210	HM212011	Yes	Outboard
WEN10-00106-102	10	Bolt On	Long	Aluminum	HM218210	HM212011	Yes	Outboard
WEN10-00112-101	10	Bolt On	Long	Aluminum	HM518410	HM518410	Yes	Outboard
WEN10-00114-101	10		Long					Unimount

Tech Tip Identification

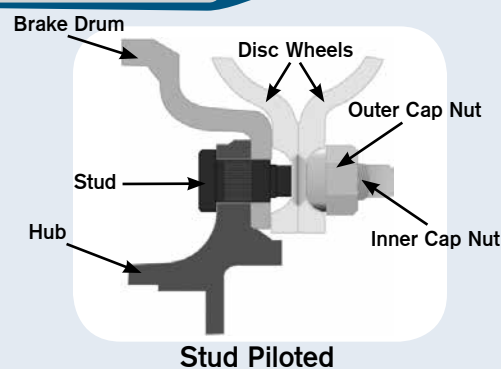
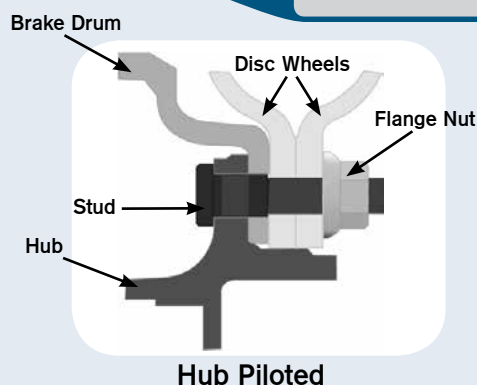

Wheel End

Hubs

Stud Piloted

Part Number	Stud Number	Hubcap Type	Stud Length	Wheel	Inner Bearing Cup	Outer Bearing Cup	Tone Ring	Mount
WEB10209--ML	10	Bolt On	Short	Steel	HM218210	HM212011	No	Outboard
WEB10209--MR	10	Bolt On	Short	Steel	HM218210	HM212011	No	Outboard

Accessories

Tone Rings

PROHUB-13237



Pro-Par
For PROHUB-00125LT, PROHUB-00125T, PROHUB-130LT, PROHUB-130T, PROHUB-143LT & PROHUB-143T

MTR09001867



Meritor
ABS

Hubcaps



WEBB

pro-par
ONE PART DAILY PARTS

Hubs & Drums

WHL

Hubcaps

Grease Application

Part Number	Spindle	Bolt Holes	Bolt Circle	Venting	Window	Cap Material	Gasket
CRS1343	TN	6	5-1/2 - 5-9/16 in.	Yes	-	Zytel	CRS453795
CRS1399	TP	6	6-3/4 in.	Yes	-	Zytel	CRS450799
CRS1399B	TP	6	6-3/4 in.	Yes	-	Zytel	CRS450799
DUADG6G	TN	6	5-1/2 in.	No	-	-	-
DUADG7.5G	TP	6	6-3/4 in.	No	359-6095	Aluminum	STE330-3118
DUADGPG	TP	Threaded	-	No	-	-	-
FRUACC7538-GRS	TP	Threaded	-	No	-	-	-
HENVS-32056-3	HP	6	-	-	-	-	-
HENVS-32070-3	HP	6	-	-	-	-	-
MTR31437-00*	TP	6	6-3/4 in.	-	-	-	-
NAT342-009	TN	6	5-1/2 in.	Yes	WK6095	Aluminum	GKT009
NAT342-195	TP	6	6-3/4 in.	Yes	WK6095	Aluminum	GKT195
NAT352-195DB	TP	6	6-3/4 in.	Yes	-	-	-
PROWH-CA003	TN	6	5-1/2 in.	Yes	-	Steel	-
STE300-5097		6	5-1/2 in.		359-5995	-	STE330-3009
STE340-4370		6	5-1/2 in.		359-5995	-	STE330-3009
STE340-5096	TN	6	5-1/2 in.	Yes	-	Steel	STE330-3009
STE342-4009	TN	6	5-1/2 in.	Yes	359-6095	Aluminum	STE330-3009
STE342-4195	TP	6	6-3/4 in.	Yes	359-6095	-	STE330-3118
STE352-4009	TN	6	5-1/2 in.	Yes	-	Aluminum	STE330-3009
STE352-4195	TP	6	6-3/4 in.	Yes	-	-	STE330-3118
STE358-4009	TN	6	5-1/2 in.	Yes	359-6146	-	STE330-3009
STE358-4195	TP	6	6-3/4 in.	Yes	359-6146	-	STE330-3118
TIM87009	TN	6	5-1/2 in.	Yes	-	Steel	95009
TIM87085B		6	6-3/4 in.	Yes	-	Steel	-

*PSI Ready

Grease/Oil Application

Part Number	Spindle	Bolt Holes	Bolt Circle	Venting	Window	Cap Material	Gasket
PROWH-CA001	TN	6	5-1/2 in.	Yes	-	Aluminum	PROWH-GA001
PROWH-CA005	TN	6	5-1/2 in.	Yes	-	Aluminum	PROWH-GA001
PROWH-CA007	TN	6	5-1/2 in.	Yes	-	Aluminum	PROWH-GA001
STE300-4009	TN	6	5-1/2 in.	Yes	359-5995	Aluminum	STE330-3009
STE340-4009	TN	6	5-1/2 in.	Yes	359-5995	Aluminum	STE330-3009
STE343-4009	TN	6	5-1/2 in.	Yes	359-5995	Aluminum	STE330-3009
STE347-4195		6	6-3/4 in.				STE330-3118
TIM81909B	TN	6	5-1/2 in.	Yes	-	Aluminum	PROWH-GA001



Hubs & Drums

WHL

Hubcaps

Oil Application

Part Number	Spindle	Bolt Holes	Bolt Circle	Venting	Window	Cap Material	Gasket
CRS1282	TF	Threaded	6-3/4 in.	-	-	Lexan	454051
CRS1612		6	4-1/2 in.	Yes	-	Zytek	CRS453869
CRS1643	TF	6	5-1/2 - 5-9/16 in.	Yes	-	Zytek	CRS453795
CRS1643B	TF	6	5-1/2 - 5-9/16 in.	Yes	-	Zytek	CRS453795
CRS1696		6	6-3/4 in.	Yes	-		CRS450799
CRS1743	TN	6	5-1/2 in.	Yes	-	Steel	CRS450755
DUADG6PSI	TN	6	5-17/32 in.	Yes	-	Aluminum	CRS453795
HENVS-32055-1	HN	-	-	-	-	-	-
HENVS-32056-1	HP	-	-	-	-	-	-
HENVS-32070-1	HP	-	-	-	-	-	-
MTR31439-00	TP	6	6-3/4 in.	-	-	-	-
MTR32283-00	TN	6	5-17/32 in.	Yes	-	Aluminum	CRS453795
MTR32515-00	HP	6	6-3/4 in.	-	-	-	-
NAT340-195	TP	6	6-3/4 in.	Yes	WK5995	Aluminum	GKT195
NAT343-350	TN	6	5-1/2 in.	Yes	WK6130	Aluminum	GKT009
NAT343-352	TP	6	-	Yes	WK6130	Aluminum	GKT195
PROWH-CA004	TP	Threaded	-	Yes	-	Polycarbonate	-
PROWH-CA006	TP	Threaded	-	Yes	-	Polycarbonate	-
STE340-4013	TN	5	5-1/2 in.	Yes	STE359-5995	Aluminum	STE330-3013
STE340-4024		6	4-1/2 in.	Yes	STE359-5999	Aluminum	STE330-3024
STE340-4195	TP	6	6-3/4 in.	Yes	STE359-5995	Aluminum	STE330-3118
STE340-4975	TP	Threaded	6-1/4 in. x 8 UN	Yes	-	Polycarbonate	STE330-3077
STE343-4024	TP	6	4-1/2 in.	Yes	-	Aluminum	STE330-3024
STE343-4195	TP	6	6-3/4 in.	Yes	-	Aluminum	STE330-3118
STE343-4308		6	4-1/2 in.		STE330-3024	-	STE330-3024
STE343-4370*		6	5-1/2 in.		STE359-6145	-	-
STE348-4009	TN	6	5-1/2 in.	Yes	STE359-6112	Aluminum	STE330-3009
STE340-4372*	TN	6	6-3/4 in.	Yes	STE359-6141	Aluminum	STE330-3118
STE343-4372*	TN	6	5-1/2 in.	Yes	STE356-6140	Aluminum	-

*PSI Ready



Hubs & Drums



Hubs/Drums

CRS1282



Accessories

Type	Outer Diameter	Gasket
Threaded	6-3/4 in.	454051

**Tamper-Proof
CRS1343**



Accessories

Holes	Bolt Circle	Gasket
6	5-1/2 in. - 5-9/16 in.	453795

Hubcaps

**Tamper-Proof
CRS1399**

SKF

Holes	Bolt Circle	Gasket
6	6-3/4 in.	450799

Accessories

CRS1612

SKF

Holes	Bolt Circle	Gasket
6	4-1/2 in.	453869

Accessories

**TF
CRS1643**

SKF

Holes	Bolt Circle	Gasket
6	5-1/2 in. - 5-9/16 in.	453795

Accessories

CRS1696

SKF

Holes	Bolt Circle	Gasket
6	6-3/4 in.	450799

Accessories

CRS1743

SKF

Holes	Bolt Circle	Gasket
6	5-1/2 in.	450755

Accessories

**HL
DUADG6G**

Holes	Bolt Circle
6	5-1/2 in.

**TP
DUADG7.5G**

Holes	Bolt Circle
6	7-1/2 in.

**Screw-On
DUADGPG**

Pro-Par

Type	Outer Diameter
Threaded	6-1/2 in.

Hubs & Drums



WHL

Wheel End

Hubcaps

**TN
DUADG6PSI**



Holes 6 Bolt Circle -

Accessories
Gasket
453795

**HN, Dual TIREMAAX[®] PRO
HENVS-32055-1**



Holes 6 Bolt Circle -

Hendrickson

**HP, Dual TIREMAAX[®] PRO
HENVS-32056-1**



Holes 6 Bolt Circle -

Hendrickson

**HP, Dual TIREMAAX[®] PRO
HENVS-32056-3**



Holes 6 Bolt Circle -

Hendrickson

**HP, Dual TIREMAAX[®] PRO
HENVS-32070-1**



Holes 6 Bolt Circle -

Hendrickson

**HP, Dual TIREMAAX[®] PRO
HENVS-32070-3**



Holes 6 Bolt Circle -

Hendrickson

**TP, PSI
MTR31437-00**



Holes 6 Bolt Circle 6-3/4 in.

Meritor

**TP, PSI
MTR31439-00**



Holes 6 Bolt Circle 6-3/4 in.

Meritor

HENDRICKSON

MERITOR

Hubs & Drums

WHL

Hubs/Drums

Hubcaps

PSI
MTR32283-00



Meritor

Holes	Bolt Circle
6	5-1/2 in.

MTR32515-00



Meritor

Holes	Bolt Circle
6	6-3/4 in.

TP
NAT340-195



Federal Mogul

Holes	Bolt Circle	Accessories
6	6-3/4 in.	Gasket GKT195

TN with Window
NAT342-009



Federal Mogul

Holes	Bolt Circle	Accessories
6	5-1/2 in.	Gasket GKT009

TP with Window
NAT342-195



Federal Mogul

Holes	Bolt Circle	Accessories
6	6-3/4 in.	Gasket 330-3118

TN
NAT343-350



Federal Mogul

Holes	Bolt Circle	Accessories
6	5-1/2 in.	Gasket GKT009

TP with Side Fill
NAT343-352



Federal Mogul

Holes	Bolt Circle	Accessories
6	6-3/4 in.	Gasket 330-3118

TP with Duckbill Vent
NAT352-195DB



Federal Mogul

Holes	Bolt Circle
6	6-3/4 in.



Hubs & Drums



WHL

Wheel End

Hubcaps

Standard TN
PROWH-CA001



Pro-Par

Holes 6 Bolt Circle 5-1/2 in.

Accessories
Gasket PROWH-GA001

PROWH-CA002



Pro-Par

Type Threaded Outer Diameter 6-1/2 in.

Steel
PROWH-CA003



Pro-Par

Holes 6 Bolt Circle 5-1/2 in.

Non-Vented
PROWH-CA004



Pro-Par

Type Threaded Outer Diameter -

Standard TN
PROWH-CA005



Pro-Par

Holes 6 Bolt Circle 5-1/2 in.

Accessories
Gasket PROWH-GA001

Vented
PROWH-CA006



Pro-Par

Type Threaded Outer Diameter -

Standard with Side Plug TN
PROWH-CA007



Pro-Par

Holes 6 Bolt Circle 5-1/2 in.

Accessories
Gasket PROWH-GA001

STE300-4009



Stemco

Holes 6 Bolt Circle 5-1/2 in.

Accessories
Gasket 330-3009



Hubs & Drums

WHL

Hubs/Drums

Hubcaps

STE300-5097



Stemco

Holes: 6 Bolt Circle: 5-1/2 in.

Accessories

Gasket
300-5097

TN
STE340-4009



Stemco

Holes: 6 Bolt Circle: 5-1/2 in.

Accessories

Gasket
330-3009
Window Kit
359-5995

5H TN
STE340-4013



Stemco

Holes: 5 Bolt Circle: 5-1/2 in.

Accessories

Gasket
330-3013
Window Kit
359-5995

TN
STE340-4024



Stemco

Holes: 6 Bolt Circle: 4-1/2 in.

Accessories

Gasket
330-3024
Window Kit
359-5999

More Information

Popular Stemco Hubcap Options

Stemco Base Part Number	Standard Hubcap, No Side Fill	Dirt Exclusion, Grease	Standard Hubcap, Side Fill	Standard Hubcap, Hubo Window	Sentinel® Hubcap	Sentinel® Hubcap, Grease	Solid Aluminum, Grease/ Vented	Integrated Sentinel® Oil	Integrated Sentinel® Grease	Bolt Circle	Bolt Size	Number of Bolts
	340	342	343	347	348	349	352	356	358			
4009	X	X	X	X	X	X	X	X	X	5-1/2 in.	5/16 in.	6
4013	X	X	X	X	X	X		X	X	5-1/2 in.	5/16 in.	5
4024	X	X	X					X	X	4-1/2 in.	5/16 in.	6
4046	X		X		X	X		X	X	5-1/2 in.	5/16 in.	6
4075	X	X	X	X	X	X		X	X	6-1/4 in. x 8 UN(M)		
4095	X	X	X		X	X	X	X	X	5-1/2 in. x 5/16 in.		
4195	X	X	X	X	X	X	X	X	X	6-3/4 in.	5/16 in.	6
4249	X	X	X							5-1/2 in.	5/16 in.	6
4281					X	X				5-17/32 in.	3/8 in.	6
4370*	X		X							5-1/2 in.	5/16 in.	6
4371*	X		X							6-1/4 in. x 8 UN(M)		
4372*	X		X							6-3/4 in.	5/16 in.	6

Legend

- 340 - No Pipe Plug
- 342 - Dirt Exclusion Grease
- 343 - With Pipe Plug
- 348 - Sentinel® Oil
- 349 - Sentinel® Grease
- 350 - With ESP Sentinel® Plug
- 353 - With ESP Sentinel® Plug
- 356 - Sentinel® Oil Integrated
- 358 - Sentinel® Grease Integrated
- 4009 - Tapered Spindle "TN"
- 4195 - Parallel Spindle "TP"

* PSI Ready

Wheel End

Hubcaps

TP
STE340-4195



Stemco

Holes	Bolt Circle
6	6-3/4 in.

Accessories

- Gasket 330-3118
- Window Kit 359-5995

PSI
STE340-4370



Stemco

Holes	Bolt Circle
6	5-1/2 in.

Accessories

- Gasket 330-3009

PSI without Magnet
STE340-4372



Stemco

Holes	Bolt Circle
6	6-3/4 in.

Accessories

- Gasket 330-3118

STE340-4975



Stemco

Type	Outer Diameter
Threaded	6-1/4 in. x 8 UN

Accessories

- Gasket 330-3077

TN
STE340-5096



Stemco

Holes	Bolt Circle
6	5-1/2 in.

Accessories

- Gasket 330-3009

Dirt Exclusion TN
STE342-4009



Stemco

Holes	Bolt Circle
6	5-1/2 in.

Accessories

- Gasket 330-3009
- Window Kit 359-6095

Dirt Exclusion TP
STE342-4195



Stemco

Holes	Bolt Circle
6	6-3/4 in.

Accessories

- Gasket 330-3118
- Window Kit 359-6095

TN
STE343-4009



Stemco

Holes	Bolt Circle
6	5-1/2 in.

Accessories

- Gasket 330-3009



Hubs & Drums

WHL

Hubs/Drums

946

800.621.7949

= Key Items

www.AuroraParts.com



Designed for performance. Made with pride.
Built by STEMCO.

STEMCO CentriFuse® Brake Drum Manufacturing, Chattanooga, TN.



Wheel Kits



Lunar™ & Lunar™ HP
Air Disc Brake Pads



Aeris® Automatic Tire
Inflation Systems



Crewson™ Automatic
Brake Adjusters



Trifecta™ Pre-Adjusted
Hub Assembly



King Pin Kits



CentriFuse® Brake Drums



Air Springs



Zip-Torq®
Axle Fasteners



Wheel Seals



Heavy Duty
Bearings



Hub Caps



Hubodometers

Wheel End

Hubcaps

TP with Plug
STE343-4024



Stemco

Holes	Bolt Circle
6	4-1/2 in.

Accessories
Gasket
330-3024

TP with Plug
STE343-4195



Stemco

Holes	Bolt Circle
6	6-3/4 in.

Accessories
Gasket
330-3118

with Pipe Plug
STE343-4308



Stemco

Holes	Bolt Circle
6	4-1/2 in.

Accessories
Gasket
330-3024

PSI with Plug
STE343-4370



Stemco

Holes	Bolt Circle
6	5-1/2 in.

PSI with Pipe Plug TP
STE343-4372



Stemco

Holes	Bolt Circle
6	6-1/2 in.

STE347-4195



Stemco

Holes	Bolt Circle
6	6-3/4 in.

Accessories
Gasket
330-3118

TN Sentinel®
STE348-4009



Stemco

Holes	Bolt Circle
6	5-1/2 in.

Accessories
Gasket
330-3009

TN Solid Cap
STE352-4009



Stemco

Holes	Bolt Circle
6	5-1/2 in.

Accessories
Gasket
330-3009



Hubs & Drums

WHL

Hubs/Drums

948

800.621.7949

= Key Items

www.AuroraParts.com

Hubcaps

TP Solid Cap
STE352-4195



Stemco

Holes	Bolt Circle
6	6-3/4 in.

Accessories

Gasket
330-3118

Integrated TN
STE358-4009



Stemco

Holes	Bolt Circle
6	5-1/2 in.

Accessories

Gasket
330-3009

TP Sentinel®
STE358-4195



Stemco

Holes	Bolt Circle
6	6-3/4 in.

Accessories

Gasket
330-3118

TN Steel
TIM87009



Timken

Holes	Bolt Circle
6	5-1/2 in.

Accessories

Gasket
95009

TN
TIM81909B



Timken

Holes	Bolt Circle
6	5-1/2 in.

Accessories

Gasket
PROWH-GA001

Steel
TIM87085B



Timken

Holes	Bolt Circle
6	-

Accessories

Part Number	Height
STE610-0090	1-7/8 in.



Mounts on top of window ring with 4 replacement screws.

Stemco

Accessories

Gaskets

Part Number	Inner Diameter	Outer Diameter	Bolt Circle	Bolt Number
APT3009	4-5/16 in.	6-13/16 in.	5-1/2 in.	6
APT3067	4-5/16 in.	6-13/16 in.	5-1/2 in.	5 & 6
CRS453795	4-1/2 in.	6-1/8 in.	5-1/2 in. - 5-9/16 in.	6
HENS-32097				6
MTR2208U1113	6-3/4 in.	7-5/8 in.	6-3/4 in.	6
MTR2208-P-1160				8
PROWH-GA002	4-7/16 in.	6-3/8 in.	5-1/2 in.	12
PROWH-GA001	4-5/16 in.	6-13/16 in.	5-1/2 in.	6
STE330-3009	4-5/16 in.	6-13/16 in.	5-1/2 in.	6
STE330-3024	3-3/4 in.	5-1/8 in.	4-1/2 in.	6
STE330-3067	4-1/2 in.	6-1/4 in.	5-1/2 in.	5 & 6
STE330-3106	6 in.	8-1/4 in.	7 in.	8
STE330-3107	5-5/8 in.	8-1/2 in.	7 in.	8
STE330-3118	6-3/4 in.	7-5/8 in.	6-3/4 in.	6
STE330-3133				
PROWH-GA003	6 in.	7-35/64 in.	6-3/4 in.	6

Window Kits

Part Number	Type	Window Diameter	Window	Window Ring Gasket	Vent Plug
PROWH-WK001	Standard	3-1/2 in.	Included	Included	Included
PROWH-WK002	Hubometer				



(PROWH-WK001)

Pro-Par

Part Number	Type	Window Diameter	Window	Gasket	Window Ring Gasket	Vent Plug
STE359-5995	Standard	3-1/2 in.	359-5994	359-5991	359-3127	359-5990
STE359-5999	Standard	2-3/4 in.	359-5983	359-5996	359-3136	359-5990
STE359-6117	Standard	3-1/2 in.	359-5981	359-5991	359-3127	-
STE359-6141	PSI					



(STE359-5995/
STE359-5999)



(STE359-6117)



(STE359-6141)

Stemco



Hubs & Drums

WHL

Accessories

O-Rings

Pro-Par	Qty	PROWH-OR001
	50	
	1	PROWH-OR002

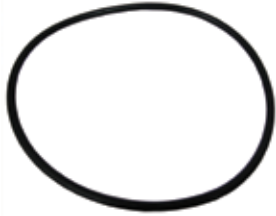

STEMCO STE330-3077

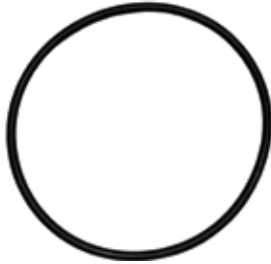

Size: 6-1/4 in.

Plugs

SKF CRS450434



Color: Green

STEMCO DUA137



Color: Blue



Pro-Par **Vented**
PROWH-PL001



Color: Black

Pro-Par **Extra Long Stem**

Type	PROWH-PL003
Vented	
Non-Vented	PROWH-PL002





(PROWH-PL003) (PROWH-PL002)

Color: Black
Material: Duro Rubber

STEMCO **Hubcap Plug**

Type	STE359-5915
Non-Vented	
Vented	STE359-5990

(STE359-5915) (STE359-5990)

Color: Red



Wheel End

Cross Reference

Trailer Axle

Oil Seals Guide

Step 1. Select Your Application:		19,000# Trailer Axle Standard Forge, Dana, Meritor, Eaton	20,000# Trailer Axle, Meritor, Shuler	22,050# Trailer Axle, Meritor, Standard Forge, Dana, Eaton	Pro-Par Trailer Axle, Fruehauf, Eaton P-22, Meritor TP, Dana
Step 2. Select Your Bearings:	Inner	653/663	653/665A	HM218210/HM218248	HM518410/HM518445
	Outer	553/560 HM212011/HM212049	HM212011/HM212049	HM212011/HM212049	HM518410/HM518445
Step 3. Select Seal:					
Manufacturer	Type				
Stemco	Discover	STE373-0213		STE373-0243	STE373-0223
	Grit Guard	STE372-7098	STE372-7095	STE372-7097	STE372-7099
	Guardian	STE307-0713	STE307-0744	STE307-0743	STE307-0723
	Voyager	STE373-0113	STE373-0144	STE373-0143	STE373-0123
National	Gold	NAT380036A	NAT380037A	NAT380025A	NAT380065A
	Red	NAT370036A	NAT370037A	NAT370025A	NAT370065A
Scotseal	Classic	CRS40136	CRS43752	CRS46305	CRS42623
	Plus XL	CRS40129	CRS47754	CRS46300	CRS42627
Pro-Par			PROWS0025A	PROW0065A	
TriSeal/Timken		TIM12S40000	TIM12S43750	TIM12S46251	TIM12S42500
Meritor		MTRMER0113		MTRMER0143	MTRMER0123
Dana Outrunner		EAT850	EAT853	EAT859	EAT851
Boss		B40136	B370037	B370025	B42623
			B43752		B370065

Front Axle

Step 1. Select Your Application:		Navistar Front Axle, FA 309, FA 329	12,000# Front Axle, Navistar	16,000# Front Axle, Ford, Navistar, Mack, Meritor, White, Ken- worth, Western Star, Peterbilt, Volvo GM	12,000# Front Axle, Meritor, Eaton, Ford, Freightliner, Kenworth, Western Star, Navistar, Peterbilt, Volvo GM
Step 2. Select Your Bearings:	Inner	632/641	632/641	6420/6461A	39520/39581 553X/557A HM212011/HM212044 HM212011/HM212049 HM212011/HM212049X HM212011/HM212047
	Outer	3920/3979	28622/28682	552A/555S	3720/3782 3525/3585
Step 3. Select Seal:					
Manufacturer	Type				
Stemco	Discover			STE383-0264	STE383-0236
	Grit Guard			STE382-8064	STE382-8036
	Guardian	STE308-0853	STE308-0856	STE308-0864	STE308-0836
	Voyager	STE383-0153	STE383-0156	STE383-0164	STE383-0136
National	Gold		NAT380131A	NAT380048A	NAT380001A
	Red	NAT370124A	NAT370131A	NAT370048A	NAT370001A
Scotseal	Classic	CRS44922	CRS45103	CRS43764	CRS35066
	Plus XL	CRS44916	CRS45095	CRS43761	CRS35058
Pro-Par				PROWS0001A	
TriSeal/Timken		TIM10S45000	TIM10S45001	TIM10S43750	TIM10S35000
Meritor					MTRMER0236 MTRMER0136
Dana Outrunner		EAT855	EAT857	EAT863	EAT847
Boss			B45103	370048	B35066
				B43764	

Hubs & Drums

WHL

Hubs/Drums

952

800.621.7949

= Key Items

www.AuroraParts.com

Cross Reference

Drive Axle

Oil Seals Guide

Step 1. Select Application:		34,000# Drive Axle, Mack	38,000# Drive Axle Mack, GMC, Eaton, Meritor	38,000# 46,000# Tadem Axles, Eaton, Ford, Freightliner, Kenworth, Western Star, Peterbilt, Meritor, Navistar, Volvo GM	38,000# Drive Axle, Eaton, Meritor, White	
Step 2. Select Bearings:	Inner	572/580	592A/594A	592A/594	672/681A	
		572/582		592A/594A		592A/598
	Outer	563/567	572/580	592A/598A		572/575
			572/582	572/575		
Step 3. Select Seal:						
Manufacturer	Type					
Stemco	Discover	STE393-0203		STE393-0273		
	Grit Guard	STE392-9094	STE392-9132	STE392-9131	STE392-9087	
	Guardian	STE309-0903	STE309-0960	STE309-0973	STE309-0970	
	Voyager	STE393-0103		STE393-0173		
National	Gold	NAT38022A		NAT380003A		
	Red	NAT370022A	NAT370005A	NAT370003A	NAT370006A	
Scotseal	Classic	CRS45099	CRS48000	CRS47697	CRS47699	
	Plus XL	CRS45093	CRS48002	CRS47692		
Pro-Par				PROWS0003A		
TriSeal/Timken		TIM11Y45001	TIM11S47671	TIM11S47670	TIM11S47672	
Meritor		MTRMER0103		MTRMER0173		
Dana Outrunner		EAT856	EAT860	EAT861		
Boss		B45099	B370005	B47697	37006A	
					B47699	

Drive Axle (cont.)

Step 1. Select Application:		17,000# Single and 34,000# Tandem, GMC	34,000# Drive Axle, Eaton, Ford, Navistar, White	33,000# Drive Axle, Mack
Step 2. Select Bearings:	Inner	47620/47686	5735/5760	652/663
			47620/47685	HM516410/HM516449
	47620/47686		HM516410/HM516449A	
	47620/47678			
Outer	39520/39590	572/575	572/575	
		39520/39590	47620/47679	
		39520/39585		
Step 3. Select Seal:				
Manufacturer	Type			
Stemco	Discover	STE393-0212	STE393-0212	STE393-0204
	Grit Guard	STE392-9045	STE392-9099	STE392-9090
	Guardian	STE309-0915	STE309-0912	STE309-0904
	Voyager	STE393-0112	STE393-0112	STE393-0104
National	Gold		NAT380023A	NAT380031A
	Red	NAT370024A	NAT370023A	NAT370031A
Scotseal	Classic	CRS38750	CRS38780	CRS42672
	Plus XL	CRS38746	CRS38776	CRS42973
Pro-Par				
TriSeal/Timken		TIM11S38750	TIM11S38751	TIM11S42500
Meritor			MTRMER0112	MTRMER0104
Dana Outrunner		EAT848	EAT849	EAT852
Boss		B38750	B38780	B370031
			B370023	

Hubs & Drums

WHL

Seals

National Seal

Part Number	Type	Spindle	Bearing
NAT386590A	Gold	Parallel	
NAT380001A	Gold	Steer Axle	HM212049/218248
NAT380003A	Gold	Drive Axle	598A/580
NAT380023A	Gold	Drive Axle	47685/39590
NAT380025A 	Gold	Tapered	HM212049/21824
NAT380036A	Gold	Tapered	663/HM212049
NAT380048A	Gold	Steer Axle	6461A/3920
NAT380065A	Gold	Parallel	HM518445
NAT370001A	Red	Steer Axle	HM212049/218248
NAT370003A	Red	Drive Axle	598A/580
NAT370014A	Red		
NAT370023A	Red	Drive Axle	47685/39590
NAT370025A 	Red	Tapered	HM212049/218248
NAT370031A	Red	Drive Axle	663/575
NAT370036A	Red	Tapered	663/HM212049
NAT370048A	Red	Steer Axle	6461A/39
NAT370065A	Red	Parallel	HM518445
NAT376590A	Red	Parallel	



Gold

Seals utilize chemical resistant, durable polytetrafluoroethylene on the main sealing lip with sufficient contact area to accommodate wheel end movement.



Red

Elastomeric seal provides a traditional material alternative.

Federal Mogul

Pro-Par

Part Number	Type	Spindle	Bearing	Tool
PROWS0001A	Unitized	Steer Axle	HM212049/HM218248	PROWSRD307/PROWSRD406
PROWS0003A	Unitized	Drive Axle	598A/580	PROWSRD305/PROWSRD416
PROWS0025A	Unitized	Tapered	HM212049/HM218248	PROWSRD306/PROWSRD413
PROWS0065A	Unitized	Parallel	HM518445	PROWSRD310/PROWSRD412
PROWS35058	Hand	Steer Axle	HM212049/HM218248	Hand Installed
PROWS42627	Hand	Parallel	HM518445	Hand Installed
PROWS46300	Hand	Tapered	HM212049/218248	Hand Installed
PROWS47691	Hand	Drive Axle	598A/580	Hand Installed



Unitized

Unitized - single piece installation, contaminant exclusives is good, nitrile rubber, no spring pops, spindle gasket and bore sealant



Hand Installed

Hand installed - unitized, one-piece installable design seal, good sealing life, high quality NBR material, clean running surfaces, installs quickly

Pro-Par

Seals

Scotseal®

Part Number	Type	Spindle	Bearing
CRS35066	Classic	Steer Axle	212049/218248
CRS38780	Classic	Drive Axle	47685/39590
CRS40136	Classic	Tapered	663/HM212049
CRS42623	Classic	Parallel	HM518445
CRS43764	Classic	Steer Axle	6461A/3920
CRS46305	Classic	Tapered	HM212049/HM218248
CRS47697	Classic	Drive Axle	598A/580
CRS35058	PlusXL	Steer Axle	212049/218248
CRS40129	PlusXL	Tapered	663/HM212049
CRS42627	PlusXL	Parallel	HM518445
CRS46300	PlusXL	Tapered	HM212049/218248
CRS47691	PlusXL	Drive Axle	598A/580



Classic

Designed to handle a range of road and driving conditions. Three-lip sealing element contains a pre-lube, spring-loaded primary sealing lip, a dirt exclusion lip, and an outer bumper lip.



PlusXL

Features an advanced new hydrogenated nitrile butadiene rubber material that resists wheel end temperatures up to 300° F and offers broad compatibility with synthetic lubricants.

SKF

Tech Tip

Pro-Par Seal Installation Tool

Seal	Handle (A)	Seal Plate (B)	Bearing Pilot (C)
PROWS0001A	PROWSRD296	PROWSRD307	PROWSRD406
PROWS0003A	PROWSRD296	PROWSRD305	PROWSRD416
PROWS0025A	PROWSRD296	PROWSRD306	PROWSRD413
PROWS0065A	PROWSRD296	PROWSRD310	PROWSRD412

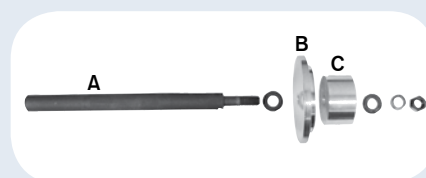

Hubs & Drums



WHL

Seals

Stemco

Part Number	Type	Spindle	Bearing
STE373-0223	Discover	Parallel	HM518445
STE373-0243	Discover	Tapered	HM212049/HM218248
STE372-7097	Grit Guard	Tapered	HM212049/HM218248
STE372-7098	Grit Guard	Tapered	663/HM212049
STE372-7099	Grit Guard	Parallel	HM518445
STE392-9131	Grit Guard	Drive Axle	598A/580
STE307-0723	Guardian HP	Parallel	HM518445
STE307-0743	Guardian HP	Tapered	HM212049/218248
STE373-0113	Voyager	Tapered	663/HM212049
STE373-0123	Voyager	Parallel	HM518445
STE373-0143	Voyager	Tapered	HM212049/HM218248
STE383-0136	Voyager	Front Axle	
STE393-0173	Voyager	Drive Axle	598A/580



Grit Guard

Seal features a two-piece design with a spindle installed deflector ring. Provides dirt exclusion for extended seal performance & insures a new surface for the sealing lip.



Discover

Seal features a high temperature elastomeric co-polymer sealing element combined with Teflon. Sealing element is protected by a four-zone labyrinth to provide unmatched contaminant exclusion & performance.



Voyager

Seal features a bonded rubber outer diameter & piloted entry ensuring an easy & square installation. The ribbed rubber outer diameter also forms a superior seal between the seal case and the hub bore.



Guardian HP

Advanced seal that has been developed for extra protection & greater sealing with a high performance sealing lip, superior contamination exclusion & self-lubricating thrust pad.

Stemco

Triseal/Timken

Part Number	Type	Spindle	Bearing
TIM12S46251	Unitized	Tapered	HM218248/HM212049
TIM11S47670	Unitized	Drive Axle	598A/580
TIM12S42500	Unitized	Parallel	HM518445
TIM12S42500B	Unitized	Parallel	HM518445
TIM12Y42501	Leather	Parallel	HM518445
TIM12Y46250	Leather	Tapered	HM212049/HM218248



Seal features three nitrile lip contact barrier points. With an oversized double-walled, reinforced metal outer diameter. Corrosion proof spacers feature multiple vent holes for enhanced lubrication.

Triseal/Timken

Aluminum Wheels

Part Number	Size	Mounting Holes	Piloted	Polished
ACC41644SP	22-1/2 in. x 8-1/4 in.	10	Hub	Standard
ACC41644XP	22-1/2 in. x 8-1/4 in.	10	Hub	Extra



Accuride

Part Number	Size	Mounting Holes	Piloted	Polished Style
PROWH225825ALM	22-1/2 in. x 8-1/4 in.	10	Hub	Machine Finish
PROWH225825ALP	22-1/2 in. x 8-1/4 in.	10	Hub	2 Side Polish



Pro-Par

Poly Separator Plate

Part Number	Stud Diameter	Bolt Circle	Piloted
ACC5901	7/8 in. & 1/8 in.	11-1/4 in.	Stud
ACC5902	3/4 in.	11-1/4 in.	Stud
ACC5903	22 mm	285.75 mm	Hub
ACC790-2	22 mm	275 mm	Hub



(ACC5901)



(ACC5902)



(ACC5903)



(ACC790-2)

Accuride



Wheels

WHL

Wheel End

Steel Wheels

Part Number	Size	Mounting Holes	Piloted	Color	Hand Holes
ACC51408PKWHT21	22-1/2 in. x 8-1/4 in.	10	Hub	White	2
ACC50308PW	22-1/2 in. x 8-1/4 in.	10	Hub	White	2



Accuride

Part Number	Size	Mounting Holes	Piloted	Color	Hand Holes
PROWH1756758HP4W	17-1/2 in. x 6-3/4 in.	8	Hub	White	4
PROWH22582510HP2W	22-1/2 in. x 8-1/4 in.	10	Hub	White	2
PROWH22582510HP5W	22-1/2 in. x 8-1/4 in.	10	Hub	White	5
PROWH22582510SP2W	22-1/2 in. x 8-1/4 in.	10	Stud	White	2
PROWH24582510HP2W	24-1/2 in. x 8-1/4 in.	10	Hub	White	2
PROWH24582510SP2W	24-1/2 in. x 8-1/4 in.	10	Stud	White	2



Pro-Par

Steel Rims

PROWH225825TLDMRW



Size: 22-1/2 in. x 8-1/4 in.
Color: White

Pro-Par

ACCURIDE

pro-par
DON'T MEET DATA, PUSH IT.

Wheels

WHL

Steel Spacer Bands

Corrugated

Color	Size	
White	20.00 in. x 4.00 in.	ACC4020CSB

Accuride



Material: Steel

Smooth

Part Number	Size	Color	Material
LSASB3315K	15 in. x 3-3/8 in.	White	Steel
LSASB4015K	15 in. x 4 in.	White	Steel
LSASB3320K	20 in. x 3-3/8 in.	White	Steel
LSASB3520K	20 in. x 3-5/8 in.	White	Steel
LSASB4020K	20 in. x 4 in.	White	Steel
LSASB4220K	20 in. x 4-1/4 in.	White	Steel
LSASB4420K	20 in. x 4-1/2 in.	White	Steel
LSASB3522K	22 in. x 3-5/8 in.	White	Steel
LSASB4022K	22 in. x 4 in.	White	Steel
LSASB4222K	22 in. x 4-1/4 in.	White	Steel
LSASB4422K	22 in. x 4-1/2 in.	White	Steel



More Information

Pro-Par Website

Need additional information on Pro-Par products?
Visit the Pro-Par website at www.Pro-Par.com.



WHEELS
ACCURIDE

WHL

Wheel Attaching Parts

Flanged Nut

Part Number	Thread	Hex	Height	Type
PROWF920	M22 x 1.5	32.75 mm	26 mm	Teflon Coated
DAY08-205578	M22 x 1.5	33 mm	32 mm	Teflon Coated
PROWF333B	M22 x 1.5	33 mm	32 mm	Teflon Coated
NUTNW221527	M22 x 1.5	37 mm	27 mm	Unimount
PROWF881M	M22 x 1.5	38 mm	35 mm	Teflon Coated
MOT88881-10	M22 x 1.5	38 mm	35 mm	Hub Piloted (NOTE: MOT88881 = pack of 60 nuts)



(PROWF920)



(DAY08-205578)



(PROWF333B)



(NUTNW221527)



(PROWF881M)



(MOT88881-10)

Inner Cap Nuts

Part Number	Inner Thread	Outer Thread	Length	Location	Material	Type	Additional
PROWF708AR	3/4 in. - 16	1-1/8 in. - 16	2-7/32 in.	Right Hand	Yellow Zinc	Budd	Grade 8
PROWF709AL	3/4 in. - 16	1-1/8 in. - 16	2-7/32 in.	Left Hand	Yellow Zinc	Budd	Grade 8
PROWF896R	3/4 in. - 16	1-1/8 in. - 16	2-9/16 in.	Right Hand	Yellow Zinc	Budd	Grade 8
PROWF896L	3/4 in. - 16	1-1/8 in. - 16	2-9/16 in.	Left Hand	Yellow Zinc	Budd	Grade 8
PROWF897R	3/4 in. - 16	1-1/8 in. - 16	3-1/16 in.	Right Hand	Yellow Zinc	Budd	Grade 8
PROWF897L	3/4 in. - 16	1-1/8 in. - 16	3-1/16 in.	Left Hand	Yellow Zinc	Budd	Grade 8
PROWF978R	3/4 in. - 16	1-1/8 in. - 16	3-1/16 in.	Right Hand	Clear Zinc	Alcoa	Grade 8
PROWF978L	3/4 in. - 16	1-1/8 in. - 16	3-1/16 in.	Left Hand	Clear Zinc	Alcoa	Grade 8
PROWF988R	3/4 in. - 16	1-1/8 in. - 16	3-1/16 in.	Right Hand	Yellow Zinc	Alcoa	Grade 8
PROWF988L	3/4 in. - 16	1-1/8 in. - 16	3-1/16 in.	Left Hand	Yellow Zinc	Alcoa	Grade 8



(PROWF708AR/
PROWF708AL)



(PROWF896R/
PROWF896L)



(PROWF897R/
PROWF897L)



(PROWF978R/
PROWF978L)



(PROWF988R/
PROWF988L)



Wheel End Components

WHL

Wheel Attaching Parts

Outer Cap Nuts

Part Number	Thread	Hex	Height	Location	Material	Type	Additional
PROWF891AR	1-1/8 in. - 16	1-1/2 in.	7/8 in.	Right Hand	Yellow Zinc	Budd	-
PROWF891BR	1-1/8 in. - 16	1-1/2 in.	7/8 in.	Right Hand	Yellow Zinc	Budd	Thru-Hardened
PROWF892AL	1-1/8 in. - 16	1-1/2 in.	7/8 in.	Left Hand	Yellow Zinc	Budd	-
PROWF912R	1-1/8 in. - 16	1-1/2 in.	1-3/32 in.	Right Hand	Yellow Zinc	Budd	Heavy Duty
PROWF913L	1-1/8 in. - 16	1-1/2 in.	1-3/32 in.	Left Hand	Yellow Zinc	Budd	Heavy Duty



(PROWF912R/
PROWF913L)



(PROWF891AR/
PROWF891BR/
PROWF892AL)

Hug-A-Lug® Hex Flange Nut

Height	Hex	
27-31 mm	33 mm	ALCH-1813



Finish: Chrome

Spoke Wheel Nut

Height	Hex	Thread	
23/32 in.	1-1/4 in.	3/4 in. - 10	PROWF716



Spoke Wheel Nut

Height	Hex	Thread	
3/4 in.	1-1/4 in.	3/4 in. - 10	MTRR004963



Type: Anodized

Rim Clamps

	Height	Width	Depth	Stud
PROWF123	2-1/2 in.	2-7/8 in.	1-1/8 in.	3/4 in.
PROWF235	2-1/2 in.	2-7/8 in.	1-3/4 in.	3/4 in.
PROWF993	2-1/2 in.	2-7/8 in.	1-1/2 in.	3/4 in.



(PROWF993)



(PROWF235)



(PROWF123)



Wheel Attaching Parts

Wheel Studs

Part Number	Thread Size	Overall Diameter	A	B	C	D	Location	Type
PROWF449	3/4 in. - 16	29/32 in.	2-19/32 in.	1-9/32 in.	1-5/16 in.	31/32 in.	Right Hand	Budd
PROWF450	3/4 in. - 16	29/32 in.	2-19/32 in.	1-9/32 in.	1-5/16 in.	31/32 in.	Left Hand	Budd
MTRR004968L	3/4 in. - 16	25/32 in.	2-7/8 in.	1-1/2 in.	1-1/4 in.	1/2 in.	Left Hand	Budd
MTRR004968R	3/4 in. - 16	25/32 in.	2-7/8 in.	1-1/2 in.	1-1/4 in.	1/2 in.	Right Hand	Budd
PROWF851	3/4 in. - 16	25/32 in.	2-7/8 in.	1-1/2 in.	1-1/4 in.	1/2 in.	Right Hand	Budd
PROWF852	3/4 in. - 16	25/32 in.	2-7/8 in.	1-1/2 in.	1-1/4 in.	1/2 in.	Left Hand	Budd
PROWF947	3/4 in. - 16	25/32 in.	2-31/32 in.	1-13/32 in.	1-1/16 in.	1/2 in.	Left Hand	Budd
PROWF948	3/4 in. - 16	25/32 in.	2-31/32 in.	1-13/32 in.	1-1/16 in.	1/2 in.	Right Hand	Budd
MTRR004969L	3/4 in. - 16	25/32 in.	3-1/8 in.	1-3/4 in.	1-1/4 in.	1/2 in.	Left Hand	Budd
MTRR004969R	3/4 in. - 16	25/32 in.	3-1/8 in.	1-3/4 in.	1-1/4 in.	1/2 in.	Right Hand	Budd
PROWF133	3/4 in. - 16	25/32 in.	3-11/32 in.	1-9/32 in.	1-27/32 in.	1/2 in.	Right Hand	Gunite
PROWF134	3/4 in. - 16	25/32 in.	3-11/32 in.	1-9/32 in.	1-27/32 in.	1/2 in.	Left Hand	Gunite
DAY09-001910	3/4 in. - 16	57/64 in.	2-5/8 in.	1-1/64 in.	1-3/8 in.	1/2 in.	Right Hand	-
DAY09-001911	3/4 in. - 16	57/64 in.	2-5/8 in.	1-1/64 in.	1-3/8 in.	1/2 in.	Left Hand	-
PROWF430	3/4 in. - 16	31/32 in.	2-27/32 in.	13/16 in.	1-1/8 in.	1/2 in.	Right Hand	Webb
PROWF431	3/4 in. - 16	31/32 in.	2-27/32 in.	13/16 in.	1-1/8 in.	1/2 in.	Left Hand	Webb
WEB101172	3/4 in. - 16	31/32 in.	2-27/32 in.	13/16 in.	1-1/8 in.	1/2 in.	Right Hand	Webb
WEB101173	3/4 in. - 16	31/32 in.	2-27/32 in.	13/16 in.	1-1/8 in.	1/2 in.	Left Hand	Webb

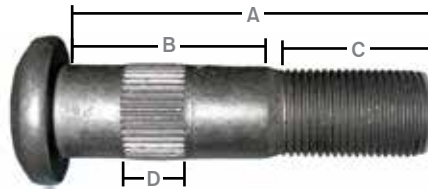

Cross Reference

Wheel Studs

Wheel Studs

Pro-Par	Meritor	Webb
PROWF133	MTRR008979R	-
PROWF134	MTRR008979L	-
PROWF183	MTRR004969R	-
PROWF184	MTRR004969L	-
PROWF263	MTRR004966R	-
PROWF264	MTRR004966L	-
PROWF287L	MTRR005896L	-
PROWF287R	MTRR005896R	-
PROWF430	MTRR009010R	WEB101172

Pro-Par	Meritor	Webb
PROWF431	MTRR009010L	WEB101173
PROWF481	MTRR005871L	-
PROWF482	MTRR005871R	-
PROWF851	MTRR004968R	WEB198510
PROWF852	MTRR004968L	WEB198521
PROWF947	MTRR008947L	-
PROWF948	MTRR008947R	-
PROWF968	MTRR004967R	-
PROWF969	MTRR004967L	-

Metric Wheel Studs

Pro-Par	Meritor	Webb
PROWF160	MTRR006034	WEB101160
PROWF162	MTRR006035	WEB101162
PROWF335	MTRR005997	-
PROWF336	MTRR005999	-

Pro-Par	Meritor	Webb
PROWF423	MTRR008981	-
PROWF437	MTRR0010221	-
PROWF676	MTRR0010676	-
PROWF883	MRTT005992A	-



Wheel End Components

WHL

Wheel Attaching Parts

Metric Wheel Studs

Part Number	Thread Size	Overall Diameter	A	B	C	D	Type
PROWF335	M22 x 1.5	57/64 in.	3-21/32 in.	29/32 in.	2-29/64 in.	13/32 in.	Budd
MTRR0010257	M22 x 1.5	57/64 in.	4-11/64 in.	3/8 in.	3-17/64 in.	-	Walther
PROWF336	M22 x 1.5	57/64 in.	4-41/64 in.	29/32 in.	3-47/64 in.	13/32 in.	Budd
CMT10001331	M22 x 1.5	-	5-5/32 in.	1-3/8 in.	-	-	-
PROWF437	M22 x 1.5	57/64 in.	5-11/32 in.	1-9/16 in.	3-7/16 in.	1/2 in.	Conmet
MTRR006035	M22 x 1.5	31/32 in.	3-15/16 in.	23/32 in.	2-11/16 in.	3/8 in.	Webb
PROWF162	M22 x 1.5	31/32 in.	3-15/16 in.	23/32 in.	2-11/16 in.	3/8 in.	Webb
WEB101162	M22 x 1.5	31/32 in.	3-15/16 in.	23/32 in.	2-11/16 in.	3/8 in.	Webb
PROWF423	M22 x 1.5	31/32 in.	4 in.	7/8 in.	2-29/32 in.	1/2 in.	Gunite
PROWF676	M22 x 1.5	31/32 in.	4-1/4 in.	7/16 in.	3-1/4 in.	1/2 in.	Gunite
PROWF160	M22 x 1.5	31/32 in.	4-25/32 in.	23/23 in.	3-17/32 in.	3/8 in.	Webb
WEB101160	M22 x 1.5	31/32 in.	4-25/32 in.	23/32 in.	3-17/32 in.	3/8 in.	Webb
MOT500006	M22 x 1.5	-	3-27/64 in.	1/2 in.	2-37/64 in.	-	MotorWheel
DAY09-001989	M22 x 1.5	57/64 in.	3-23/32 in.	-	2-9/16 in.	-	Meritor
DAY09-002003	M22 x 1.5	57/64 in.	4-25/32 in.	-	3-27/32 in.	-	Meritor
WEN02-00014	-	22 mm.	-	-	-	-	-
WEN02-00118	-	-	-	-	-	-	-
WEN02-000-10	-	-	-	-	-	-	-

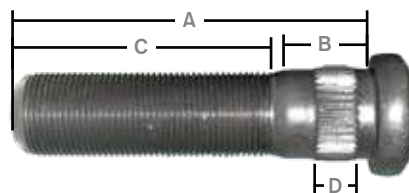

Shoulder Wheel Studs

Part Number	Thread Size	Overall Diameter	A	B	C	D	Location	Type
PROWF990	3/4 in. - 16	25/32 in.	3-31/32 in.	2-7/16 in.	1-5/32 in.	1-11/32 in.	Right Hand	Budd
PROWF991	3/4 in. - 16	25/32 in.	3-31/32 in.	2-7/16 in.	1-5/32 in.	1-11/32 in.	Left Hand	Budd
PROWF004	3/4 in. - 16	25/32 in.	4-1/32 in.	2-1/2 in.	1-9/32 in.	1-11/32 in.	Right Hand	Budd
PROWF005	3/4 in. - 16	25/32 in.	4-1/32 in.	2-1/2 in.	1-9/32 in.	1-11/32 in.	Left Hand	Budd
MTRR005560R	3/4 in. - 16	25/32 in.	4-1/16 in.	2-1/2 in.	25/64 in.	1-3/8 in.	Right Hand	

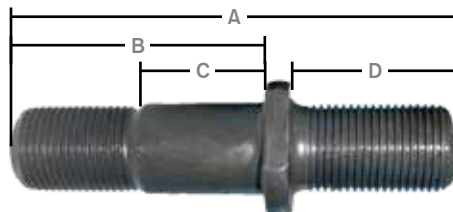

Wheel End Components

WHL

Wheel End

Wheel Attaching Parts

Spoke Wheel Studs

Part Number	Thread Size	A	B	C	Type
MTRR004956A	3/4 in. - 10	3 in.	1-1/16 in.	1-3/4 in.	Grade 8
PROWF715	3/4 in. - 10	3 in.	1-1/16 in.	1-3/4 in.	Grade 8

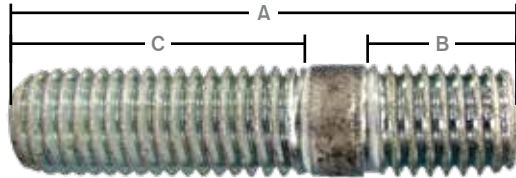

Drum Mounting Kit FRUACD2813-900



Item	Count	Diameter	Thread	Length
Bolts	5	3/4 in.	16	2.00 in.
Nuts	5	3/4 in.	16	
Flat Washers	10	3/4 in.		

Drum Bolt Assembly PROWF807



Item	Count	Diameter	Thread	Length
Bolts	5	5/8 in.	18	2.00 in.
Nuts	5			
Flat Washers	5			

Drum Bolt Kit PROWF809



Item	Count	Diameter	Thread	Length
Bolts		3/4 in.	16	2.00 in.
Nuts				
Flat Washers				

Valve Stems & Components

Valve Stem Core HALA-100-VC-1



Heltec

Valve Stem Cap HALA-100-VC-3



Heltec



Wheel End Components

WHL

Valve Stems & Components

HALTV509



Haltec

Length: 4-3/4 in. Angle: 90°
For Aluminum wheels; complete with all fittings, valve cap and valve core

Double Seal Valve Stem Cap HALDS-1



Haltec

Material: Metal
Inflation without removing cap

HALTV545D



Haltec

For Aluminum wheels

Grommet Seal Valve HALTV-555D



Haltec

Height: 63/64 in. Length: 2-5/8 in.
Bend Angle: 60

Haltec	Length	HALTV572
	3-3/4 in.	
Haltec	Length	HALTV573
	4-3/8 in.	



For Steel wheels; complete with all fittings, valve cap and valve core

SCH545D



Schrader

Length: 2-5/16 in. Angle: 60°
For Aluminum wheels; complete with all fittings, valve cap and valve core

Valve Caps

Schrader	Finish	SCH7572B
	Black	
Schrader	Finish	SCH7572V
	Chrome	



(SCH7572B) (SCH7572V)

Dome-shaped top and guide on skirt for easy application to valve threads.

Wheel End Components



